

Varenummer: 4395000651  
Beskrivelse: Rota-fix spændelement F65x95  
Rustfast stål

## Mål

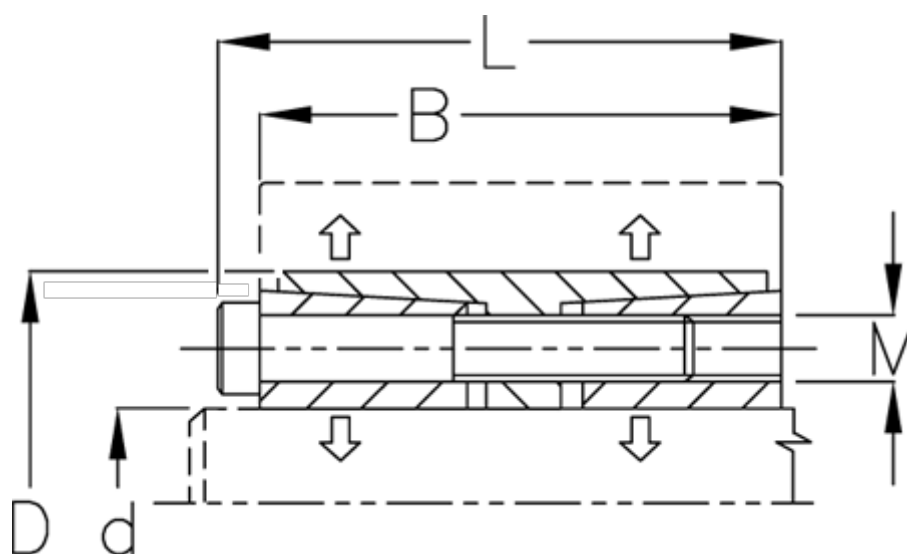

B mm	= 66
d H8 mm	= 65
D mm	= 95
F kN aksialkraft	= 109.0
L mm	= 74
M mm	= M8
Overfladeruhed	= R? ? 3.2 $\mu$ m
P N/mm <sup>2</sup> fladetryk på aksel/nav	= 33

T Nm drejningsmoment	= 3560
Tolerance	= Aksel h8, Nav H8
Ts Nm boltetilspændingsmoment	= 28.7